

# Operation Manual



BFSD-701

## Mobile Fume Extractor

# Index

---

Preface.....	3
1. Unpacking, Installation, Debugging.....	3
1.1 Unpacking of Upper Cabinet.....	3
1.2 Unpacking of Lower Cabinet.....	5
1.3 Accessories Check.....	6
1.4 Installation Conditions and Operating Environment.....	6
1.5 Installation.....	6
1.6 Inspection after Installation.....	8
2. User Instructions.....	8
2.1 Functions.....	8
2.1.1 Product Concept.....	8
2.1.2 Working theory/Air flow Pattern and Protected Area Figure.....	9
2.1.3 Protected Objects.....	9
2.1.4 Technical Parameters.....	9
2.2 Product Structure.....	10
2.2.1 Structural Composition of BFSD 500 Series Fume Hood.....	10
2.2.2 Structure Composition.....	11
2.3 Daily Maintenance.....	17
2.4 Replacement Parts List.....	18
2.5 Wiring Diagram.....	19
3. Trouble Shooting and Solution.....	19
3.1 Trouble Shooting.....	19
3.1.1 Replace the fuse.....	21
3.1.2 Replace the fluorescent lamp.....	21
3.2 Label Description.....	22
4. Warranty.....	22

## Preface

Dear respected user:

Welcome to select and purchase BFSD 500 Series Fume Hood , here please accept our sincere thanks!

We sincerely hope that our products can bring the greatest help for your work.

In order to let you be more familiar with the BFSD 500 Series Fume Hood, please carefully read the manual firstly. Being familiar with the contents of this manual can ensure you operate the equipment safely and correctly! Please keep this manual properly.

After having been familiar with the contents, please keep this manual in a place which is convenient to use for easy access.

## 01 Unpacking, Installation, Debugging

Please firstly check if the packing box is in good condition. If the packing box is damaged, please take photos.

### 1.1 Unpacking of Upper Cabinet

box 1: Method 1 Use M8 Wrench to unpack (Figure1)



Figure 1

box 1 Method 2: Necessary tools for unpacking: Electric drill with hexagon dead M8(Figure 2)



Figure 2

Quick unpacking diagram (Remove the screws, as are shown below, and then take the wooden box to the left.)

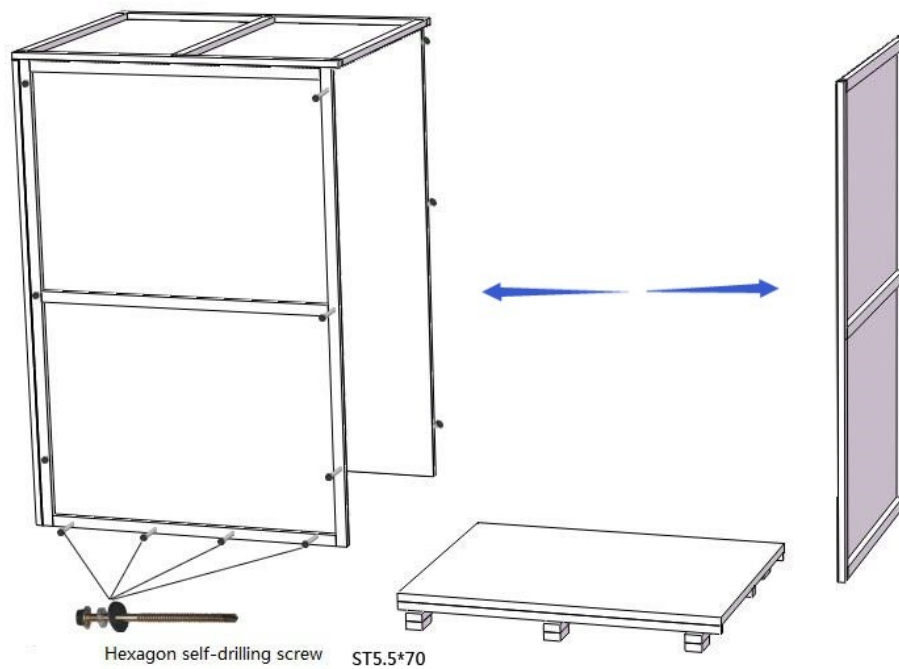

Figure 3

box2 Quick unpacking

Cut the packing tape down with a scissors, remove the upper cover of the carton, and then move carton upwards.

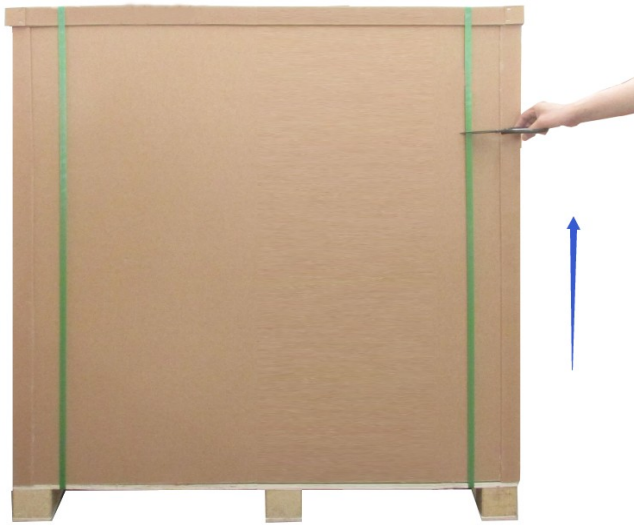

Figure 4

## 1.2 Unpacking of Lower Cabinet

box 1 Unpack with M8 wrench or electric drill

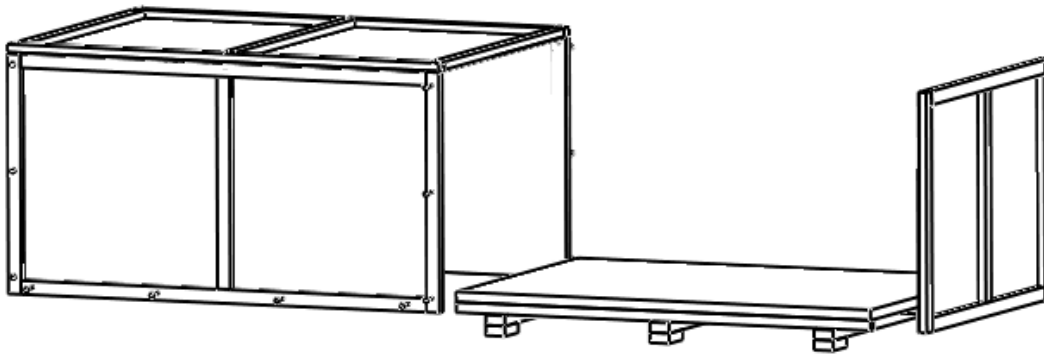

Figure 5

box 2 Cut the packing tape down with a scissors, remove the upper cover of the carton, and then move carton upwards.



Figure 6

## 1.3 Accessories Check

Please refer to the packing list, carefully check whether the accessories and information are complete.

BFSD 500 Series Fume Hood Packing List

Upper cabinet :

No.	Item	Quantity
1	Upper Cabinet	1set
2	User Manual	1copy
3	Quality Certificate	1pc
4	Test Report	1copy
5	Fuse 10A	1pc
6	Power Cord	1pc
7	Inner Hexagon Wrench	1pc

Lower cabinet(optional) :

No.	Item	Quantity
1	Lower Cabinet	1set
2	Base	1set

## 1.4 Installation Conditions and Operating Environment

Installation position of fume hood should be avoided to face road and sites people frequently go through, avoided to clog windows and places where ventilation and lighting are not good, avoided to block the entrance and exit and place where the open or close of the door is affected ,and avoided to place oppositely or in the corner of the wall.

### Working environment:

- (1) Only applicable for indoor operation
- (2) Ambient temperature: 15° C~35° C
- (3) Relative Humidity: ≤75%;
- (4) Atmospheric pressure range: 70 kPa~106 kPa;
- (5) Electrical parameters: Adequate power supply to the fume hood (See 2.1.4 Technical Parameters);
- (6) The power should be grounded (Use a multimeter to test the voltage of the live line to ground and the voltage of the null line to ground respectively, among which, the voltage of the live line to ground should be the grid power, and the voltage of the null line to ground should be 0, otherwise, the power is not grounded well).

## 1.5 Installation

- a) Remove all packaging components
- b) Check whether the outer surface of the host has scratches, deformations or foreign objects;
- c) Check carefully the accessories and information by referring to the packing list in the operating manual;

- d) Move the entire equipment to a site which is as close as possible to the position where the equipment is placed finally and convenient for installation;
- e) Check if the environment voltage frequency is the same with the voltage frequency shown in the label;

Method to connect the upper cabinet and the lower cabinet:

- (1) Place the lower cabinet in the proper installation position, brake the caster brakes, then place the upper cabinet on the lower cabinet, and let the left, right, rear side of the upper cabinet align with those of the lower cabinet;
- (2) Fix the upper and lower cabinets to prevent skidding and open the front acrylic door on the upper cabinet, and then take the accessories out: including stainless steel hexagon socket head cap bolts M10 \* 20 and stainless steel large flat washer 5, and fasten well the lower cabinet and the upper cabinet, as is shown in Figure 7

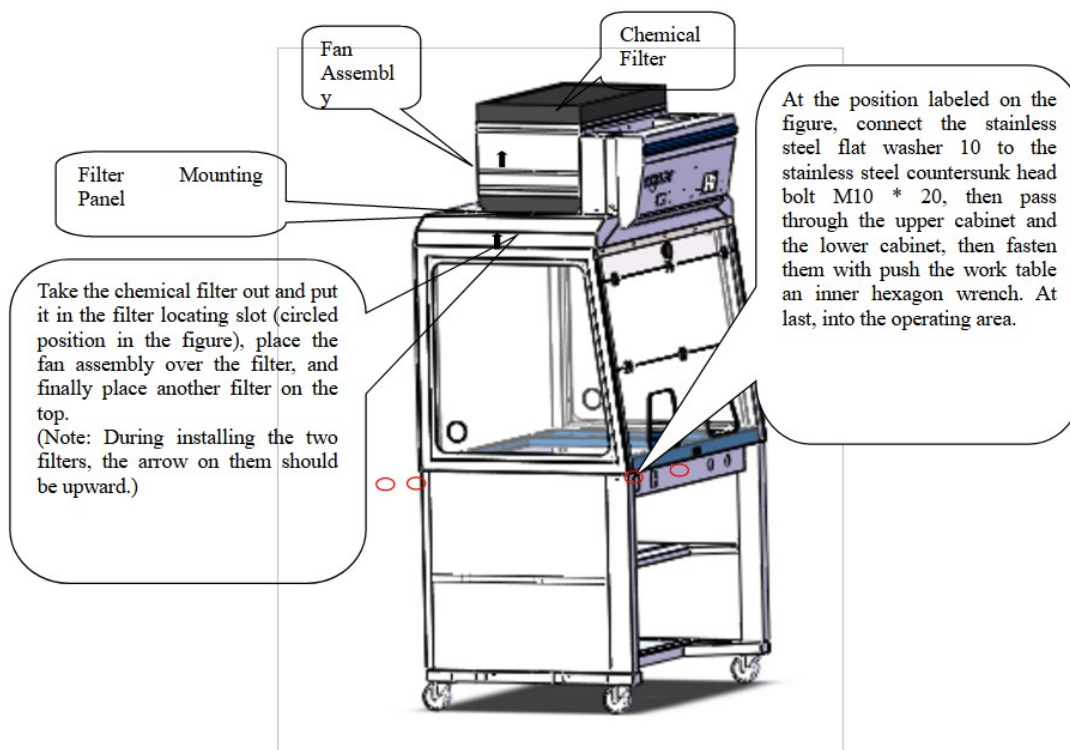

Figure 7

- (3) Take the activated carbon filter from the paper package, and put it in the filter locating slot on the filter mounting panel, and then place the fan assembly above the activated carbon filter located in the bottom, and finally place the second activated carbon filter above the fan assembly.
- (4) Connect the butt plug on the fan assembly with the butt plug on the operating panel, and fasten them well; connect the butt plug of the fluorescent lamp with the butt plug on the operating panel, and fasten them well; connect the butt plug of the VOC sensor with the butt plug on the operating panel, and fasten them well; plug the air velocity sensor plug on the corresponding position of the operating panel; plug the humidity sensor plug on the corresponding position of the operating panel.



### 1.6 Inspection after Installation

After the equipment is powered on, check the following items according to 2.3.2 :

Checking Items	Normal Working Status
Equipment power status	Connect the ambient power, the equipment can be powered on
Fan running situation	Press the fan button, the fan runs normally, press the fan air velocity button, the speed can be adjusted
Fluorescent lamp	Press the fluorescent lamp button, the lamp can be lighted up.



**If you have any questions, please contact our agent to debug. Debugging method is in the After-sale service manual.**

## 02 User Instructions

### 2.1 Functions

#### 2.1.1 Product Concept

In chemical laboratories, a lot of odors, moisture and corrosive substances will be generated during the experiment. To protect the safety of users and prevent the spread of pollutants in laboratories, fume hoods are used.

Note: Filters of BFSD 500 series non-ducted fume hood have poor adsorption effect to hydrogen, helium and inert gases, methane, ethane, ethylene oxide, carbon monoxide, carbon dioxide, nitrogen monoxide, propylene, propyne, acetylene, organophosphorus compounds Mercury, hydrogen cyanide, radioisotope. Generally speaking, the adsorption effect to gas with a molecular weight of less than 36 is not good, in such case, it is not recommended to use such a fume hood. In addition, in experiments with large amounts of volatile chemicals, experiments with large amounts of smoke, experiments with strong acid and alkali, experiments with flammable, explosive, toxic, such kind of fume hood cannot be used.



### 2.1.2 Working theory/Air flow Pattern and Protected Area Figure

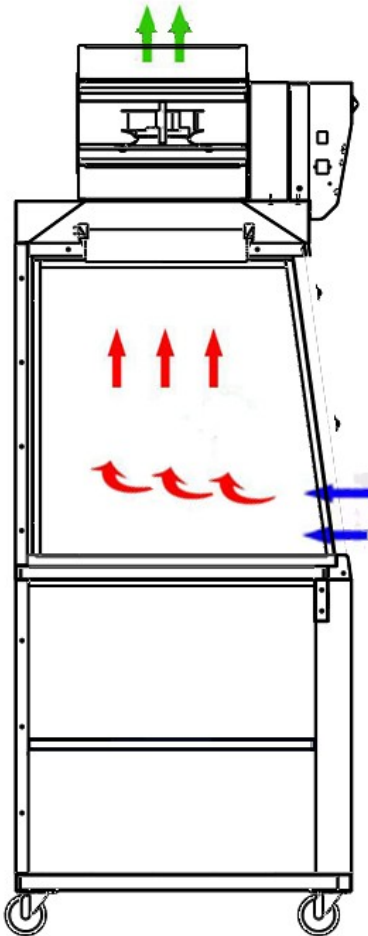

Figure 8

### 2.1.3 Protected Objects

Safety is the biggest mission pursued by fume hoods. The use of fume hoods in laboratories is to ensure the safety of users and to prevent contamination of the laboratory environment.

### 2.1.4 Technical Parameters

Mode Parameters	BFSD-501	BFSD-502	BFSD-503	BFSD-504
Rated Voltage AC	220V±10%	110V±10%		
Rated Frequency	50 Hz	60Hz		
External Size	1000*830*2140 (mm)	1200*830*2140 (mm)	1500*940*2140 (mm)	1800*940*2140 (mm)
Internal Size	910*690*740	1110*690*740	1410*690*740	1710*690*740

	(mm)	(mm)	(mm)	(mm)
Rated Power	400 W	400 W	500 W	500 W
Airflow Velocity	0.4~0.6m/s			
Fluorescent Lamp Power	220V 16W*2	220V 16W*2	220V 16W*3	220V 16W*3
UV Lamp (option)	T8 20W	T8 20W	T8 30W	T8 30W
Noise	≤54dB (A)			

**Note: (1) Power consumption does not include power consumption loaded by cabinet socket (load can not exceed 500W);**  
**(2) Biolab reserves all the rights to changes in product design , if there are any design change, we will not inform in advance.**

- 1) Vibration amplitude  
The vibration amplitude between frequency 10Hz and 10KHz should not exceed 5µm(rms).
- 2) Voltage resistance:  
The voltage increases to 1390V (AC) in 5s and keep for another 5s without breakdown.
- 3) Grounding resistance ≤0.1Ω.

## 2.2 Product Structure

### 2.2.1 Structural Composition of BFSD 500 Series Fume Hood

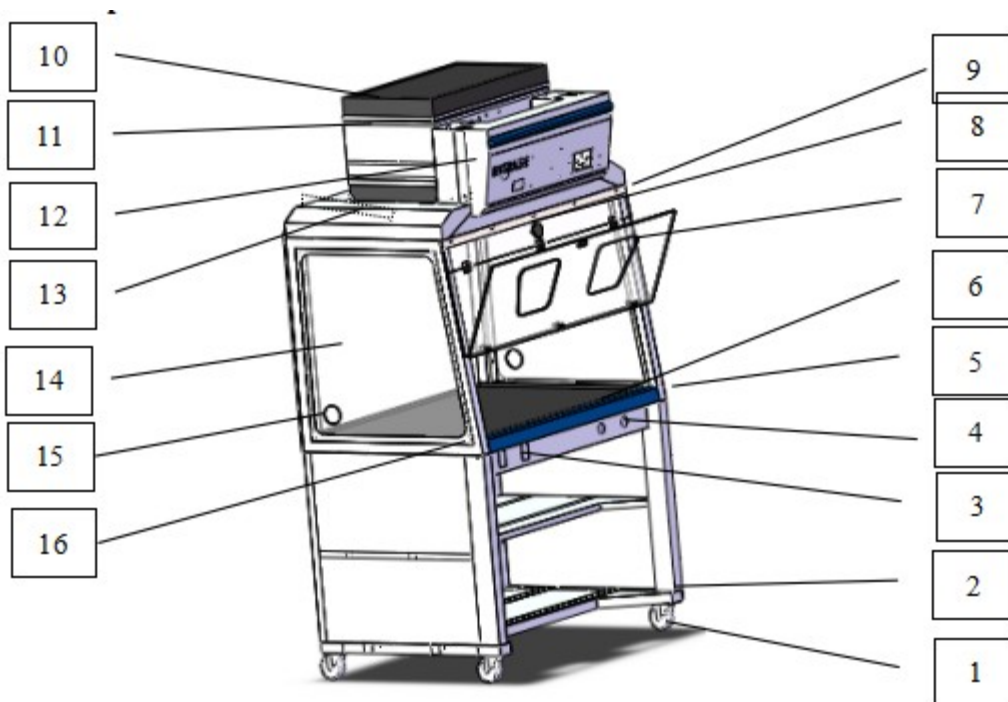

Figure 9

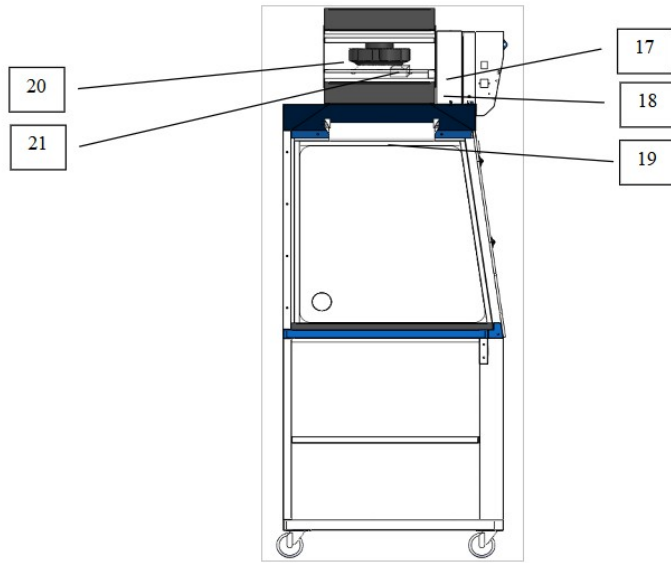

Figure 10

- |   |                         |                          |
|---|-------------------------|--------------------------|
| 1. Castor                                     | 8.Wind Speed Sensor     | 15.External Circuit Hole |
| 2. Lower Cabinet (Optional)                   | 9.Filter Mounting Panel | 16. Hand Rack            |
| 3.Socket (Optional)                           | 10. Chemical Filter     | 17. Rocker Switch        |
| 4.Control Valve for Water, Gas Tap (Optional) | 11. Fan Assembly        | 18. Tail Plug            |
| 5. Side Panel                                 | 12. Operating Panel     | 19. Fluorescent Lamp     |
| 6.Work Table                                  | 13.Fluorescent Lamp     | 20. Fan                  |
| 7.Front Window Acrylic                        | 14. Side Panel Acrylic  | 21. VOC Sensor           |

## 2.2.2 Structure Composition

### ★Lighting Source

Three anti-fluorescent lamp is used to ensure that the average illumination in the operating area is in line with standard requirements.

### ★Control Panel

#### Main Interface Description

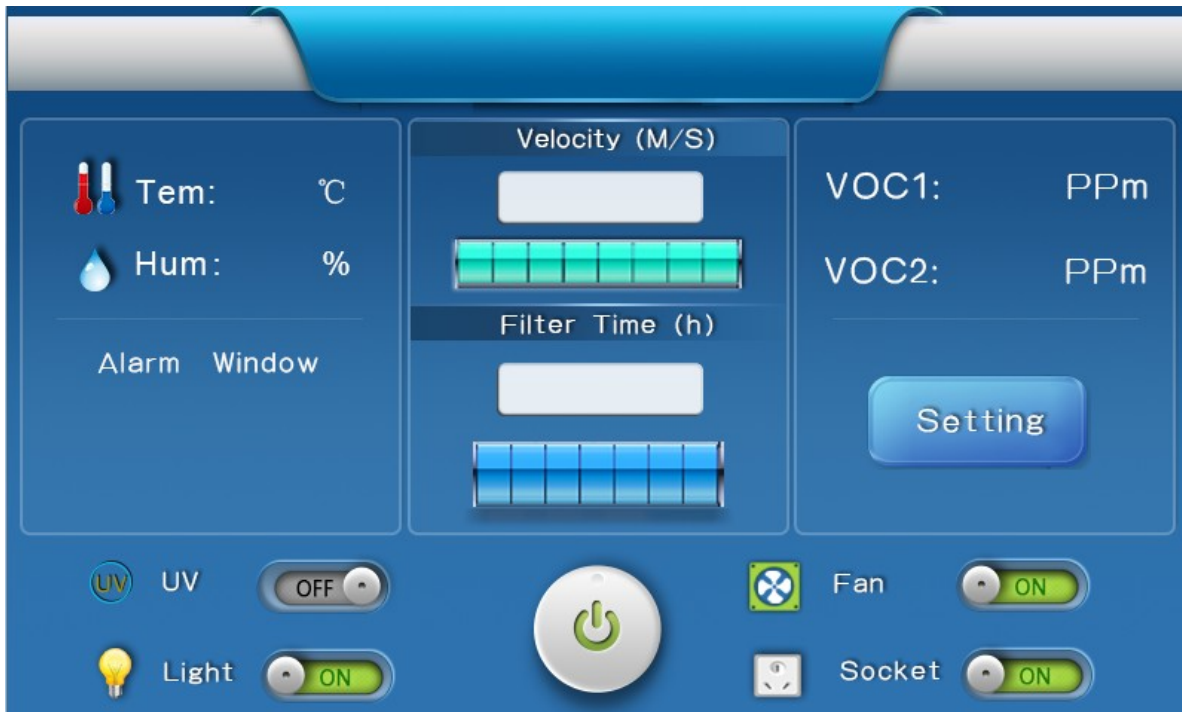

1. Power button: Under the power-on state, the icon color is green, at this time, the UV lamp, fluorescent lamp, fan, socket can be turned on and off; click the power button, and icon color turns to be red, indicating the equipment is powered off, at this time, the UV lamp, fluorescent lamp, fan, outlet can not be turned on, all components are close and the buttons have no response.



2. Fan button: When the power button is turned on, click the button, and the icon turns to be green, the fan is turned on; when the icon turns to be gray, the fan is turned off.



3. Socket button: When the power button is turned on, click the button, and the icon turns to be green and the socket is opened; when the icon turns to be gray, the socket is closed.



4. Fluorescent lamp button: when the power button is turned on, click the button, and the icon turns to be green, the fluorescent lamp is turned on; when the icon turns to be gray, the fluorescent lamp is turned off.



5. UV lamp button: when the power button is turned on, click the button, and the icon turns to be green, the fluorescent lamp is turned on; when the icon turns to be gray, the fluorescent lamp is turned off.



Temperature and humidity sensor display: Tem: temperature, Hum: humidity.



Air velocity display: The white area shows the air velocity value of the air velocity sensor at this moment. One minute after the fan is turned on, if the air velocity value is lower than the low air velocity alarm value set by the user, it will generate an alarm and prompt "Warning! Air velocity is too low"

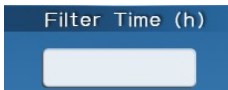

Filter time display: The white area shows the fan working time, when the time is greater than 3000 hours, it will generate an alarm and prompt "please replace the filter."



Filter time grid: As the filter time increases, the grid will slowly increase, when the grid is full, the cumulative filter time reaches 3000 hours.



Alarm window: Here shows the alarm information.

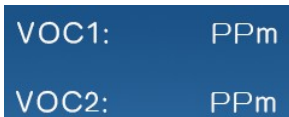

VOC sensor pollution coefficient display: The larger the value is, the more serious the air pollution is.



Setting button: Click the button, the setting interface is reached.

## Setting Interface Description:

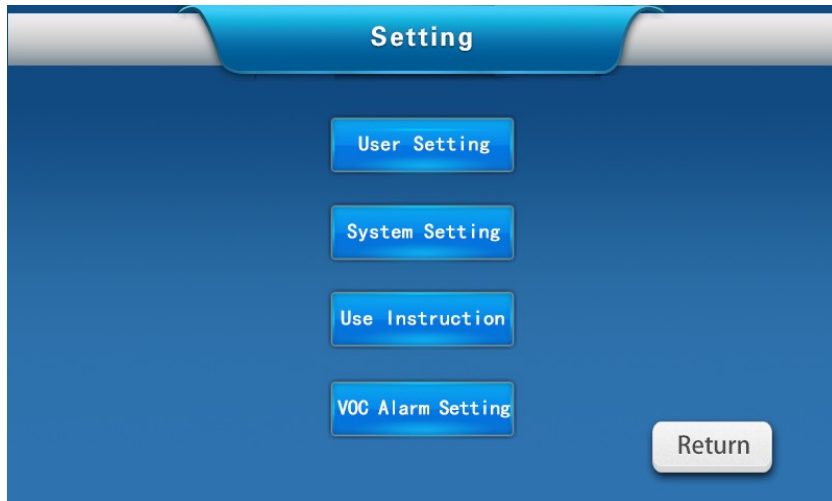

### User Setting

1. User setting: User can set low air velocity alarm value and turn on/off the fan at specified time intervals

### System Setting

2. System setting: User can modify the fan gear, debug value, clear filter, UV lamp time.

### Use Instruction

3. Use instruction: Briefly introduce the use method of the product.

### VOC Alarm Setting

4. VOC Alarm setting :  
VOC setting: used to adjust the display value and alarm value of VOC.

## User Setting Interface:

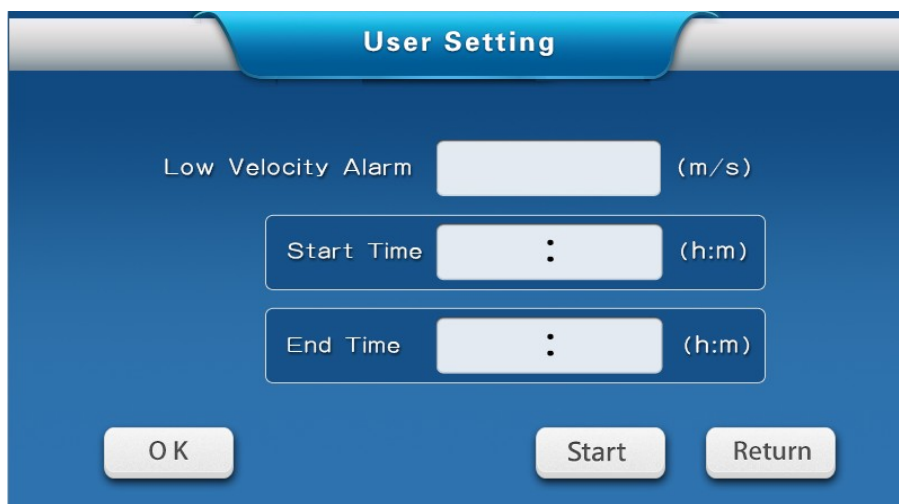

Low Velocity Alarm  (m/s)

1. Users can set low air velocity alarm value independently, one minute after the fan is turned on, if the air velocity is lower than the user-set low air velocity alarm value, the equipment will alarm.

Start Time  :  (h:m)

2. Start time of regularly start/end fan: Users can set fan start time independently, h: hour; m: minute.

End Time  :  (h:m)

3. End time of regularly start/end fan ( fan running time): Users can set fan end (running) time independently, h: hour; m: minute.

OK

4. Ok button: Click this button to memorize the low air velocity alarm value set by the user, otherwise the value can not be memorized, click the button, switch into the main interface.

Start

5. Start button: Click this button to memorize the start/end time of fan set by the user, otherwise the value can not be memorized

Return

6. Return button: Click this button to return to the main interface, and does not memorize the start/end time of fan set by the user.

### System Setting Interface:

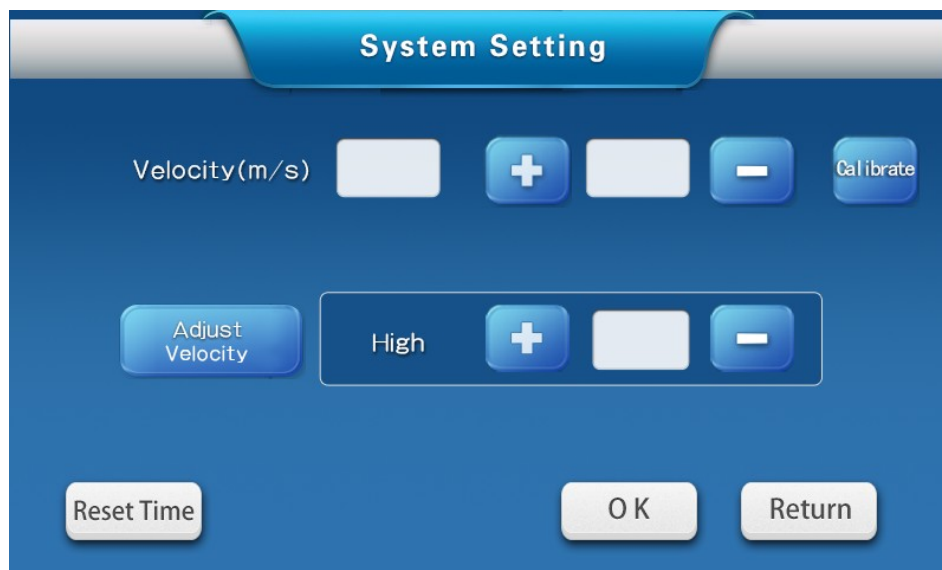





## Ductless Fume Hood

Velocity(m/s) 

1. Velocity display: The white area shows the air velocity value of the air velocity sensor at this time.





2. Debug adjust: Click the ,  to increase/decrease value, the middle area shows the debug value at this time, by which, the shown air velocity can be adjusted.

Adjust Velocity

3. Fan adjust velocity button: The fan gear can be adjusted by clicking this button.



4. Fan gear adjust: The fan gear can be adjusted by clicking the ,  buttons. All in all, there are 70 gears.

Reset Time

5. Reset time: The rest interface will be switched into by clicking this button.

OK

6. Ok button: Click the button, turn off the fan, memorize fan gear with the debug value adjusted by user, otherwise, the fan gear and the debug value adjusted by the user can not be memorized.

Return

7. Return button: Click the button, turn off the fan, while the fan gear with the debug value adjusted by user can not be memorized.

Calibrate

8. VOC

VOC calibration button: Click this button, the VOC display value is cleared, and the environment is assumed to be a clean environment. The VOC value in the environment is memorized. When the VOC value in the environment is higher than the VOC value in the memory, there will be re-displays.

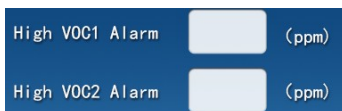
**Reset Interface:**

1. Display the current VOC alarm value, click on the blank space, pop up the keyboard to set the VOC alarm value that the user needs.



2. Click the increase and decrease button to adjust the intermediate variable of VOC display value. The left margin shows the VOC display value on the main interface.

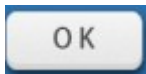

3. Confirm button: Click to save the VOC display value intermediate variable and alarm value at this time, and return to the setting interface.

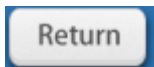

4. Back button: Click to save the VOC display value intermediate variable and alarm value before modification, and return to the setting interface.

**2.3 Daily Maintenance**

Maintenance should be done every year or every 1000 work hours, and every restart.

1. Please firstly turn off the power before conducting the daily maintenance;
2. Since the statistics of the operating time will directly affect the judgment of the maintenance needs, we recommend that you can prepare a detailed record of the operating time for reference and inquiry when you are using the equipment;
3. The fan should be checked and maintained regularly.

**Maintenance method:**

- 1) Weekly or monthly maintenance
  - a、 Surface cleaning ( refer to 2.4.1);

## Ductless Fume Hood

- b、 Check whether the various functions of the equipment are abnormal;
  - c、 Record the maintenance.
- 2) Annual maintenance
- a、 Check whether the front acrylic door and the hinge are firm.
  - b、 Check the fluorescent lamp
  - c、 Apply for the annual testing of the overall performance of the fume hood, in order to ensure the fume hood performance is safe. Testing costs shall be borne by the user.
  - d、 Record the maintenance

### 2.3.1 Surface cleaning

In order to keep the cabinet clean, please regularly (at least once a week) clean it. The wipe should be done with a dry soft cloth with soapy water being wringed. Do not spray any chemical reagents on the operating panel or other labels to prevent discoloration of the label film or the writing is unclear. Clean the outer surface of the cabinet and the acrylic door with flexible detergent or acrylic-specific cleaning agent.

### 2.3.2 Storage Conditions

Fume hood should be stored in a warehouse with the relative humidity of not more than 75%, the temperature below 40 °C, good ventilation, no acid, alkali and other corrosive gases, the storage period should not exceed one year, for the fume hood more than one year out of the box check should be done, the ones that pass the out of the box check can enter the market.

## 2.4 Replacement Parts List

### BFSD 500 Series Fume Hood Replacement Parts List

No.	Item	Specification
01	Fuse	10A
	anti-fluorescent	
02	Lamp	220V 8W*2
03	Fan	EC 125W
04	Main Control Panel	BFSD 500 Series Fume Hood Control Panel
		BFSD-501/ BFSD-502: 750*400*75mm*2
05	Filter	BFSD-503/ BFSD-504: 750*400*75mm*4
		BFSD-501/ BFSD-502: T8 20W
06	UV Lamp (option)	BFSD-503/ BFSD-504: T8 30W



<b>Faults</b>	<b>Check parts</b>	<b>Solutions</b>
Three anti-fluorescent lamp doesn't work	Switch	Check if the fluorescent lamp button has been turned on
	Circuit	Check circuit
	Control panel	Replace the control panel
	Lamp	Replace the lamp
Button doesn't work	Control panel	Make sure the power connects well and the fuse is good
		Make sure the connecting wire is connected well
		Replace the control panel
Fan doesn't work	Switch	Check if the fan button has been turned on
	Fan	If the fan is broken, replace a new one
	Circuit	Check circuit
	Control panel	Replace the control panel
No electricity in socket	Switch	Check if the socket button has been turned on
	Fuse	Check if the fuse has been broken
	Socket	Check if the socket is damaged
	Circuit	Check circuit
No electricity in equipment	Control panel	Replace the control panel
	Power supply	Check if the power supply connects well
	Power cord	Check whether power cord has obvious damage
	Fuse	Check if the fuse is good
	Transformer	Check whether the transformer works normally
Display screen doesn't work	Connection winding displacement	Check if connection winding displacement is connected well
	Display screen	Check if the display screen is good
	Control panel	Replace the control panel

## Replacement of parts:

### 3.1.1 Replace the fuse

The round fuse at the right side of the fume hood operating panel is determined by the labels, which are F5A  $\phi 5 \times 20$  mm and F10A  $\phi 5 \times 20$  mm. When the user wants to replace the socket fuse holder, firstly turn off the power supply, pull off the plug, unscrew the fuse holder counterclockwise with a Phillips screwdriver, replace a new fuse in the holder, and tighten the fuse holder clockwise. When the live line fuse needs to be replaced, unscrew the fuse holder with a flat-blade screwdriver and replace with a new one, after which, press it back.



Figure 12

### 3.1.2 Replace the fluorescent lamp

When the fluorescent lamp of the fume hood needs to be replaced, lift the acrylic door to hang it on the hook at the top of the control panel, and then disconnect the power supply, remove the three anti-fluorescent lamp power cord, unscrew the 4 screws on three anti-fluorescent lamp holder, remove the old three anti-fluorescent lamp, and replace with a new one, then connect the three anti-fluorescent lamp power cord, at last, power on for test.



Figure 13



**1) The operation of the above electrical parts must be carried out by qualified electricians under safe conditions (cut off the power supply). And other parts are not**

- allowed to disassemble, otherwise the consequences shall be borne by the user;
- 2) When the equipment has a failure which is not listed above, and the operator can not immediately rule out, please immediately notify Biolab maintenance department, for your safety, please do not repair equipment by yourself;
  - 3) The maintenance work of this equipment can only be borne by trained and recognized technical staff;
  - 4) If you need to order parts, please seek help from the technical service department, please specify the model and No. of the dispensing booth you purchased

### 3.2 Label Description

#### 3.2.1 Fuse label (Figure14)

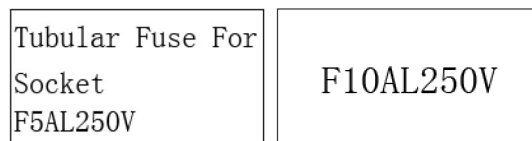

Figure14

Note : 5A fuse indication label is located below the socket fuse holder.  
10A fuse indication label is located below the power socket.

#### 3.2.2 Ground label (Figure 15)



Figure 15

## 04 Warranty

- 1) Warranty is 12 months from EX-factory date (excluding consumable accessories: UV lamp, LED lamp and fuse).
- 2) Biolab would not be liable for any repair of damage caused by improper operation.
- 3) If the warranty has been expired, Biolab would still responsible for repair with relative charges.
- 4) Life time of laminar flow cabinet is 8 years from production date on the label.
- 5) Biolab would provide equipment drawings and necessary technical data for maintenance companies or personnel trained by Biolab engineers.

**Warranty declaration: One-year Warranty, Life-long Maintenance**





Email: [contact@biolabscientific.com](mailto:contact@biolabscientific.com)  
Website: [www.biolabscientific.com](http://www.biolabscientific.com)